

# R&S® M3SR SERIES4400 RADIOS

VHF/UHF radio family for stationary  
and shipborne communications



Product Brochure  
Version 09.00

**ROHDE & SCHWARZ**

Make ideas real





2



# CONTENTS

## At a glance

► page 4

## Secure communications

► page 6

## Ease of operation

► page 8

## Unrivaled radio parameters

► page 9

## Flexible range of applications

► page 10

## Flexible and safe investment for the future

► page 12

## Low maintenance

► page 13

## Radios in a mobile ATC tower

► page 14

## Remote control and monitoring of radios

► page 15

## Voice over internet protocol (VoIP)

► page 16

## High data rate network solutions

► page 18

## Product overview

► page 19

# AT A GLANCE

To ensure secure radiocommunications and successful accomplishment of missions, today's stationary radiocommunications solutions for civil and military applications must meet extremely demanding RF requirements and also provide high operating reliability. The R&S®M3SR Series4400 radio family is designed for stationary civil and military secure voice and data communications. It features high modularity and outstanding specifications.

The R&S®M3SR Series4400 radios provide continuous AM and FM transmission coverage from 100 MHz to 512 MHz. The radios were developed in line with international civil air traffic control guidelines and standards (ICAO Annex 10, EN 300676). The radios also fulfill UHF communications requirements in line with EN 302617.

The R&S®M3SR Series4400 offers military users a wide range of interfaces and associated proprietary frequency hopping waveforms, as well as radiocommunications in line with NATO standards. Military data transmission methods such as LINK 11 and LINK 22 are supported. To ensure that existing R&S®M3SR Series4400 systems remain up-to-date, their functionality can be enhanced through subsequent software downloads and, if necessary, by using new hardware modules.

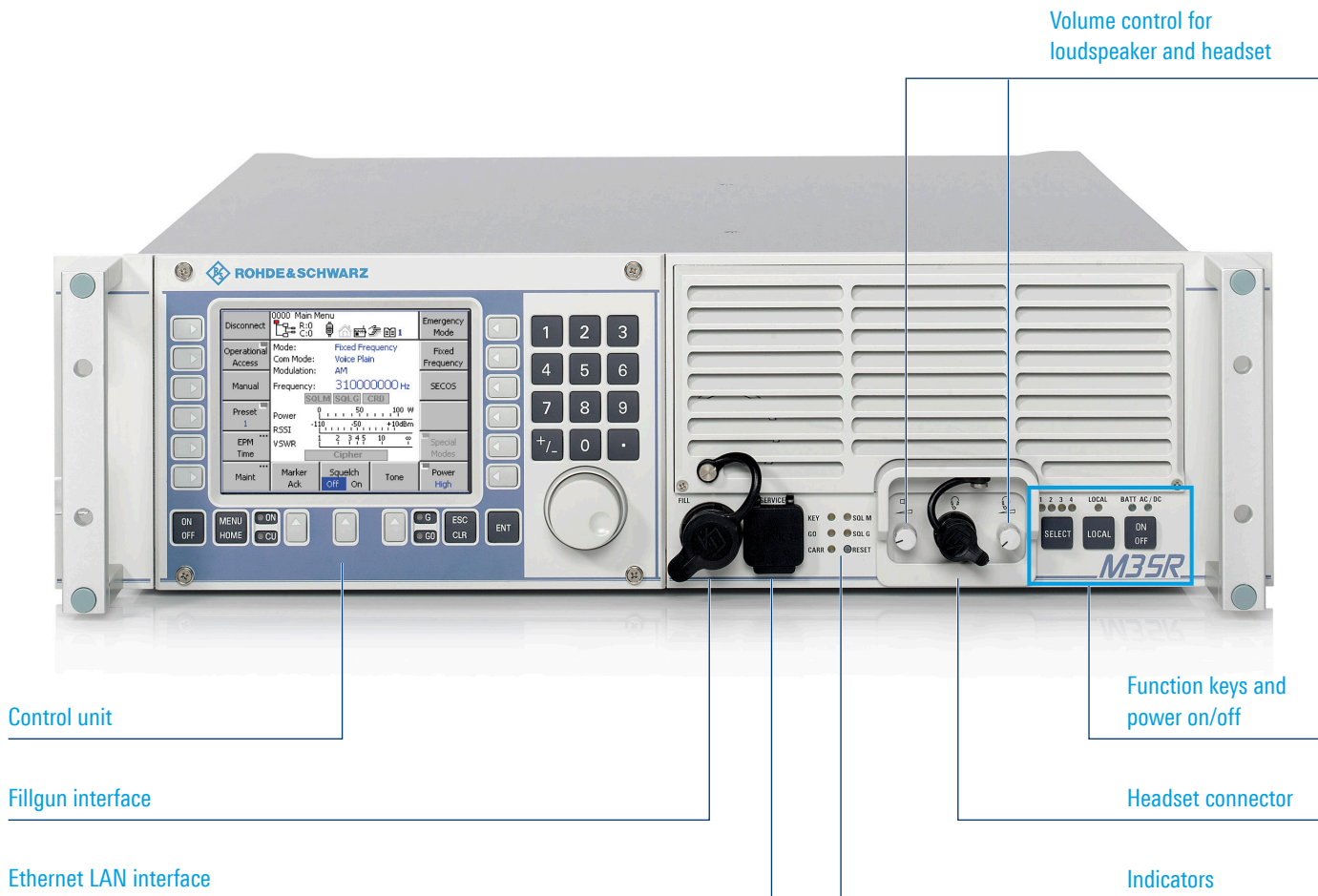

# KEY FACTS

- ▶ Extended frequency range from 100 MHz to 512 MHz for coverage of various civil and military communications modes
- ▶ Output power up to 100 W for deployment with EPM (ECCM) waveforms for increased performance
- ▶ TCP/IP based interfaces for remote control, voice over IP (VoIP) and for service/maintenance activities
- ▶ Simple network management protocol (SNMP) for establishing radiomonitoring and remote control applications with automated TRAP reporting
- ▶ Continuous transmission at temperatures up to +55 °C
- ▶ Interfaces for external cipher units and modems

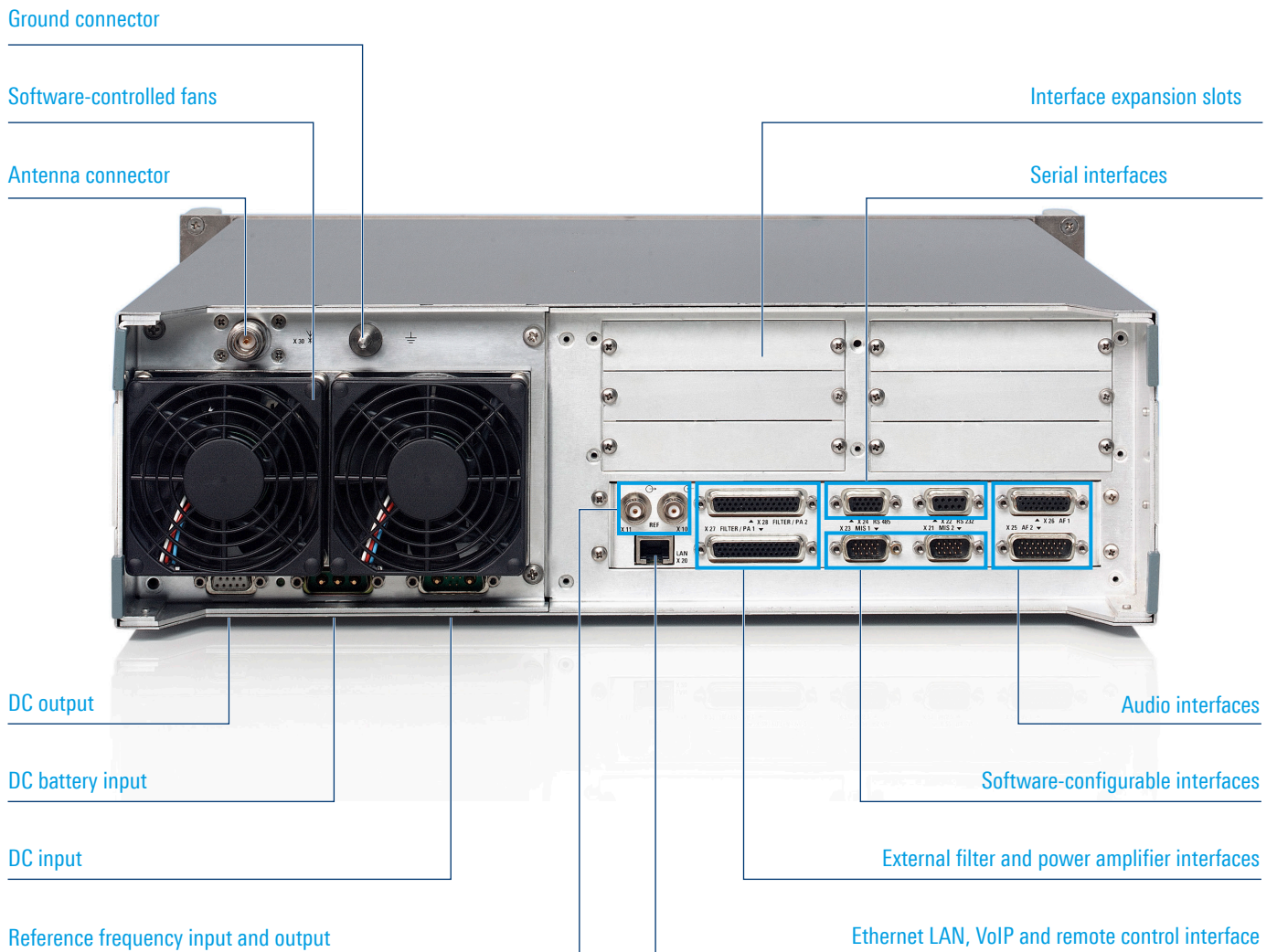

# SECURE COMMUNICATIONS

The R&S®M3SR Series4400 radio family features a range of different methods for transmitting voice and data. Such functional features are loaded in the radio as software and with optional hardware. The R&S®M3SR Series4400 radio family also has diverse standardized interfaces for connecting external modems in order to support special transmission methods. The wider transmission bandwidths enable higher throughput rates.

## NATO and proprietary EPM (ECCM) waveforms

In addition to supporting the well-established NATO EPM (ECCM) UHF waveforms HAVE QUICK II and SATURN, the R&S®M3SR Series4400 radio family features a range of proprietary waveforms. External encryption devices such as the ELCRODAT 4-2, which are used in NATO applications in conjunction with EPM (ECCM)

waveforms, can be easily connected to and operated with the R&S®M3SR Series4400. Proprietary EPM (ECCM) waveforms such as R&S®SECOS contain embedded software encryption for secure communications. Together with user-specific algorithms and methods for secure data transfer, users benefit from a comprehensive, versatile communications package. Multiple EPM (ECCM)

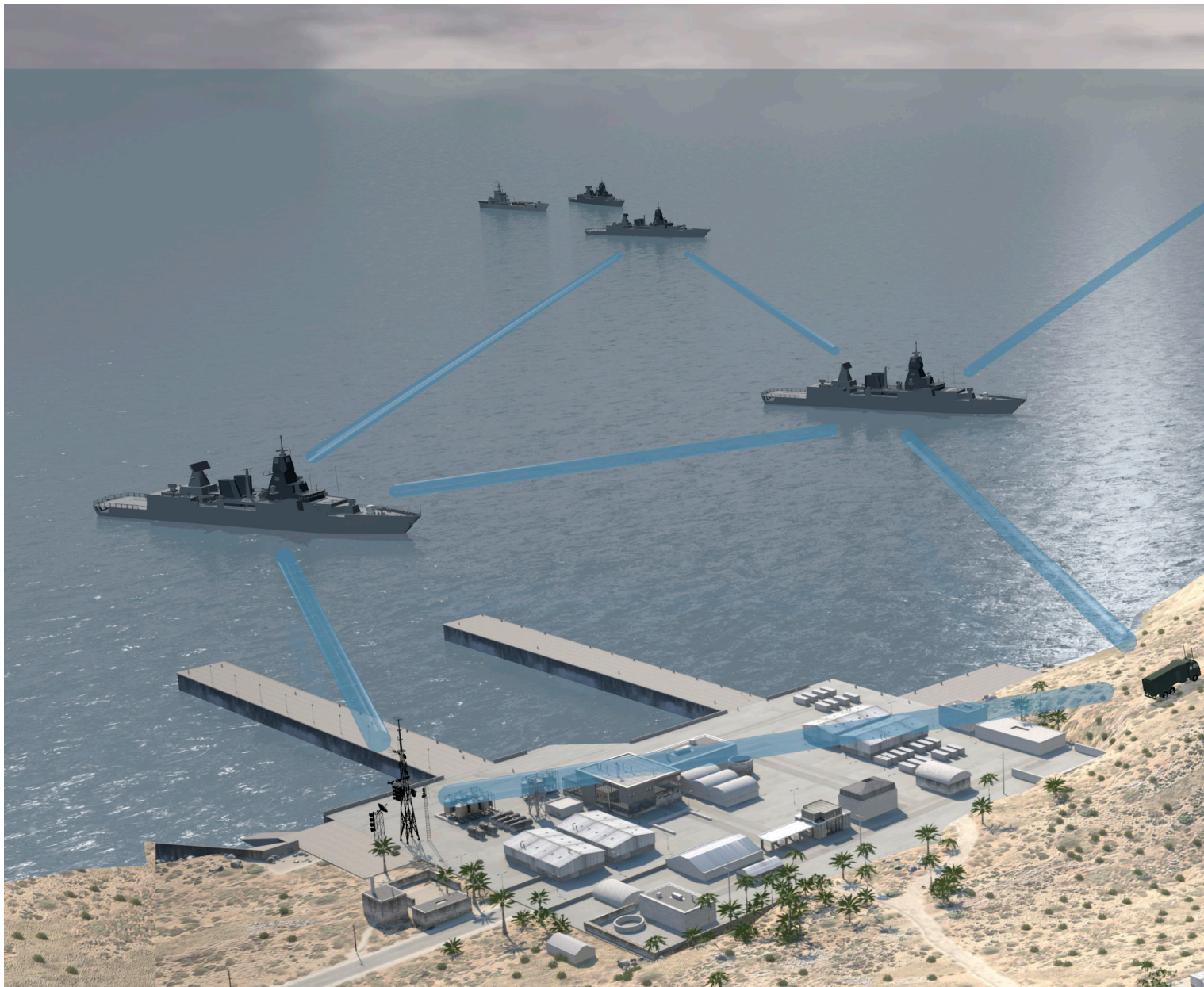

waveforms can be loaded into a radio — for instance HAVE QUICK II together with R&S®SECOS. The desired waveform can be selected by using the remote control unit or the built-in local control panel.

#### 70 MHz up-/downconverter for external modems (optional)

The R&S®UX4401 70 MHz IF converter interface module is designed for use with a variety of existing external modems that have a standard IF interface. This RF interface allows the use of diverse waveforms with wider transmission bandwidths, enabling high data rates. Fine adjustment of the radio parameters helps achieve wider coverage.

#### Methods for secure data transmission over TDMA based radio networks (optional)

Via the R&S®SECOS waveform, the R&S®M3SR Series4400 radio family supports different data transmission modes, including time division multiple access (TDMA). In a TDMA network, a large number of participants can be part of a structured data network over which data information is automatically exchanged. Network participants can switch dynamically between different TDMA networks. Multiple TDMA subnetworks can be combined into a large data network. Data can be exchanged across all subnetworks involved. Data transmission is encrypted using either fixed frequency mode or frequency hopping.

#### Interface for external encryption devices

The radio wideband interfaces of the R&S®M3SR Series4400 are specially designed for operation with external encryption devices. The radio interface supports a wide range of external encryption devices and supports baseband and diphas transmission modes.

#### Remote key loading

In conjunction with the proprietary EPM (ECCM) waveform, encrypted configuration data can be loaded directly into the R&S®M3SR Series4400 radios via the remote control interface. This data can consist of new keys or data sets for secure communications. This vastly simplifies the management, structure and configuration of such systems.

#### Support for various LINK methods

Besides EPM (ECCM) waveforms, the R&S®M3SR Series4400 radio family supports tactical digital information link (TADIL) methods such as LINK 11 and LINK 22. Both methods are an integral part of the current and future NATO communications structure.

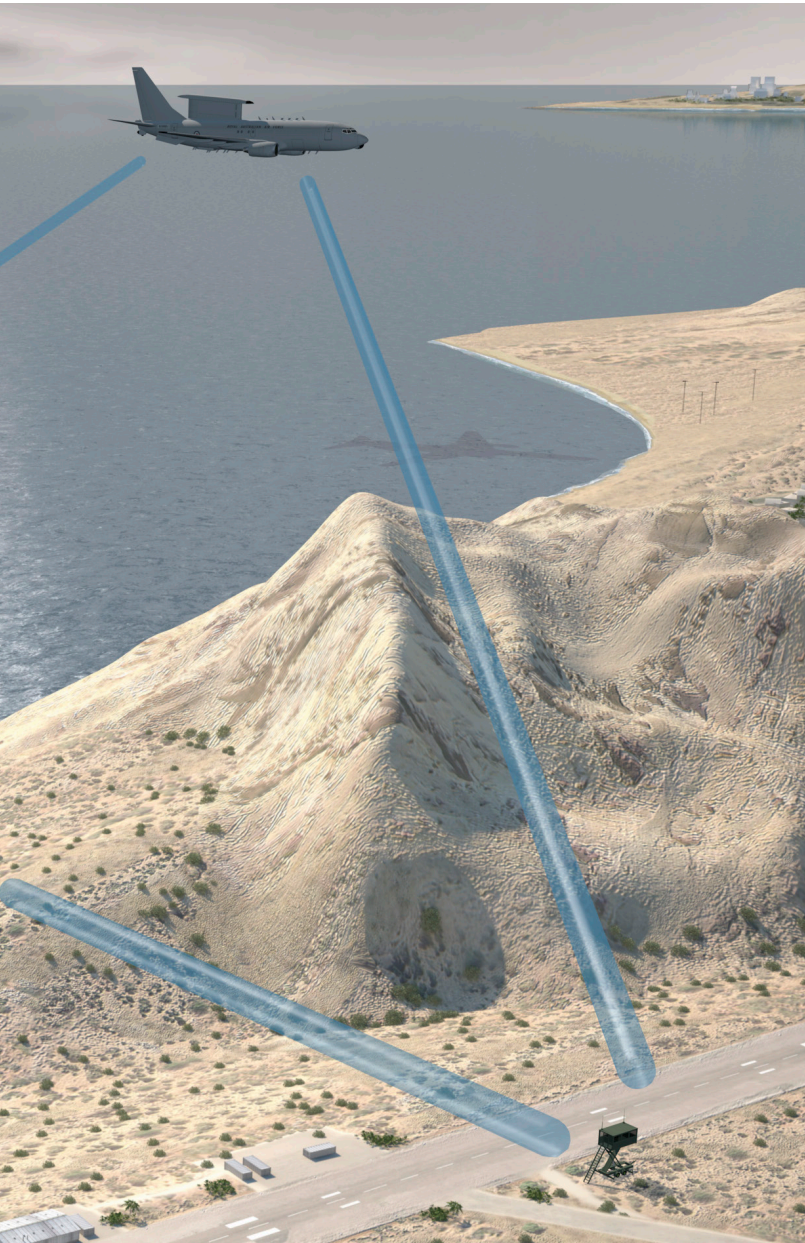

R&S®M3SR Series4400 radios used in ground, naval and airborne installations for seamless voice/data communications networks

# EASE OF OPERATION

Rohde & Schwarz has extensive experience with stationary radios, which is reflected in the operating concept of the R&S®M3SR Series4400 radios. The display and control elements are arranged in a user-friendly manner and are easy to understand.

## Intuitive graphical user interface (GUI)

Complex radio methods require an intuitive user interface. The user interface of the R&S®M3SR Series4400 radio family is clearly laid out and uses icons for intuitive control. These icons allow the user to immediately draw conclusions regarding the current operating mode of the radio without pressing a key, which significantly increases ease of operation. They also simplify orientation in the menu structure of the control unit to ensure fast and reliable configuration of the radio.

The GUI is presented on the TFT display of the R&S®GB4000C control unit, which is available as a stand-alone or built-in version.

## Password-protected access

The settings for maintenance and configuration of the radio are protected by a password. This ensures that only authorized personnel can carry out maintenance or in-depth configuration of the radio. This concept is based on many years of practical experience.

## Plain-text status and warning messages

Because status and warning messages are highly important to the user, they are visually differentiated from the rest of the display. Messages are displayed in a menu in plain text so that any user can immediately comprehend them. Critical and waveform-dependent status messages are color-coded. All warning messages are stored in the radio for later analysis. Readout and storage in an external medium is possible with the R&S®ZS4400 service and maintenance tool.

## Automatic remote control access management

For large-scale systems that have multiple local or remote control units, access management is necessary in order to enable remote control of the radios. The GUI displays the access authorization level and the status of the radio remote control links for immediate overview.

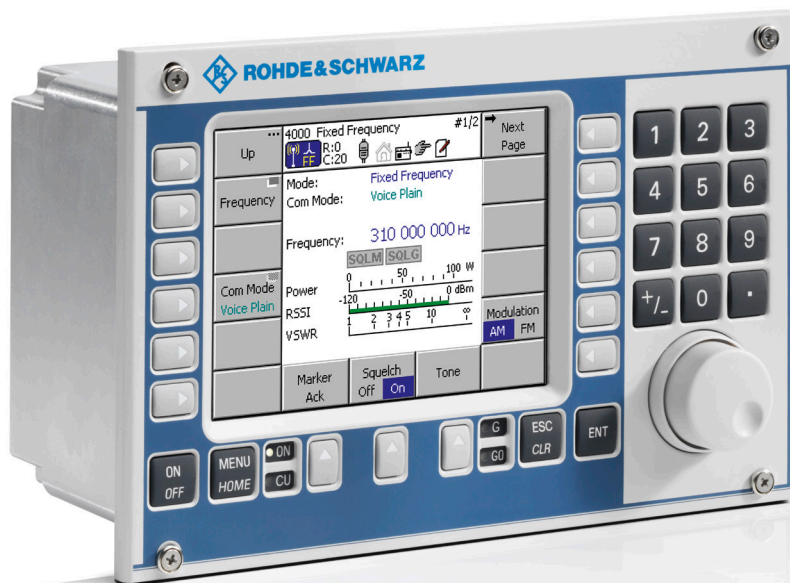

R&S®GB4000C local/remote control unit



# UNRIVALED RADIO PARAMETERS

## Excellent RF characteristics

The R&S®M3SR Series4400 radio family features excellent RF characteristics. The combination of analog and digital technology provides high signal purity that results in optimal transmission quality and extremely clear voice communications. Very fast frequency hopping and compatible filter methods yield an optimal RF signal spectrum, significantly reducing collocation influence typically caused by adjacent transmit and receive stations.

Frequency generation in the R&S®M3SR Series4400 systems is performed by a special, state-of-the-art synthesizer module to provide spectrally pure signals and ensure high-quality radio links. Very rapid frequency generation and frequency setting enables the use of fast EPM (ECCM) waveforms while retaining the high quality of the RF signals.

## Transceiver cosite considerations

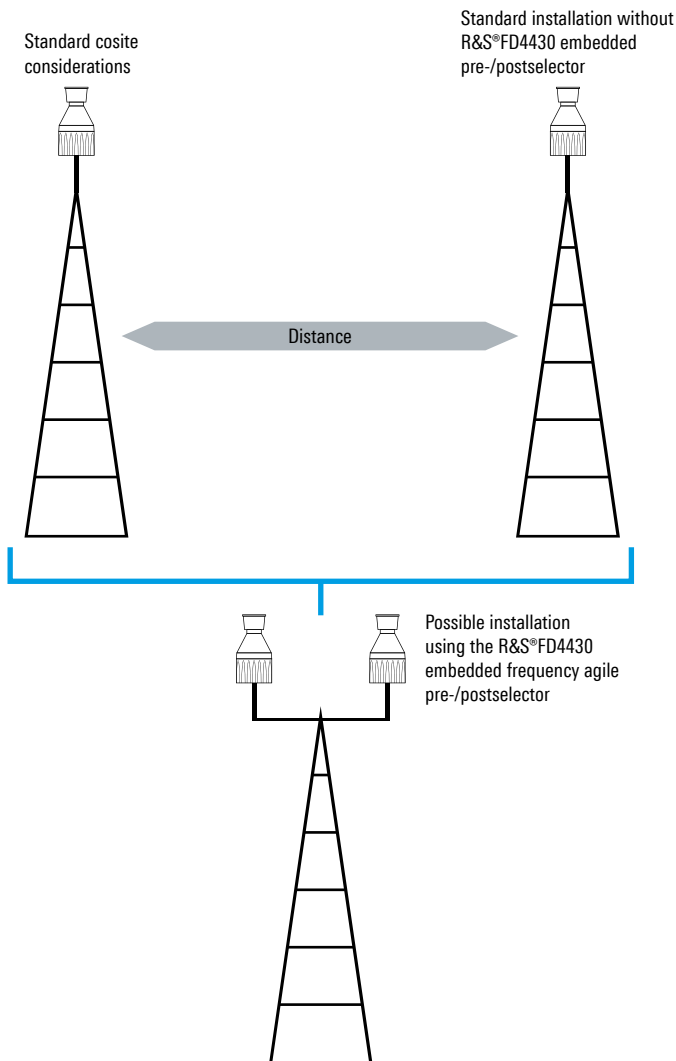

## Robust design for unfavorable RF conditions

R&S®M3SR Series4400 radios are prepared for unfavorable RF environments. Even antennas that create a high voltage standing wave ratio (VSWR) can be connected without difficulty. The impact of high receive levels is compensated for by excellent RF large-signal immunity. Protection circuits prevent damage to the R&S®M3SR Series4400 modules.

## Integratable UHF circulator with VHF bypass function for improved intermodulation rejection (optional)

The R&S®M3SR Series4400 radio family can be equipped with an optional UHF circulator. The circulator helps to significantly reduce intermodulation products, which further improves system performance.

Integrating a circulator into the radio eliminates the need for complex external circuitry and measures. The circulator is equipped with a bypass for the VHF band and is available as an upgrade kit.

## Frequency agile pre-/postselector for optimum interference-free operation (optional)

Defense communications sites often require a large number of antennas that must be properly decoupled to prevent the effects of collocation. To minimize these influences, the R&S®M3SR Series4400 radio family can be equipped with an optional filter. The R&S®FD4430 filter provides additional RF decoupling for practically interference-free operation in demanding RF environments. Wideband noise generated by the radios as well as the influence of cross-modulation are considerably reduced.

The R&S®FD4430 filter works with EPM (ECCM) waveforms. The ability to integrate the filter into the radio saves space and reduces installation effort. The filter is only suitable for radio equipment exclusively used for activities concerning public security, defense and state security.

## 70 MHz wideband interface for modem applications (optional)

The R&S®M3SR Series4400 provides a 70 MHz IF interface for operation with external modem solutions. The interface provides a wideband IF channel for high data rate applications up to Mbps. The module can adapt to different IF operating levels. The user can select the RX gain control mode and the transmitted power.

# FLEXIBLE RANGE OF APPLICATIONS

In order to meet the individual needs of the users, the R&S®M3SR Series4400 radio family features a highly modular design. Depending on the mission scenario, the radios are configurable to provide the specific functions that are required.

## Software defined radio concept

Software can be loaded into the radio using the R&S®ZS4400 service and maintenance tool. Numerous software packages are available for this purpose. This approach also allows functional enhancements to be

loaded at a later time. That means existing software functions can be enhanced without opening the radio or replacing hardware modules. The current status of the software is shown in a comprehensive inventory report, which contains the versions of the software and its components.

## Highly modular design enabling scalable radios

The R&S®M3SR Series4400 radio family features a highly modular design. The maintenance-friendly structure shortens repair times (MTTR) and makes it easy to adapt the system to user requirements. All R&S®M3SR Series4400 radios have the same base configuration, a logistical platform for scalability. The radio modules are updated by replacing them with new versions. The modular design allows the radio to be equipped with new functions and options.

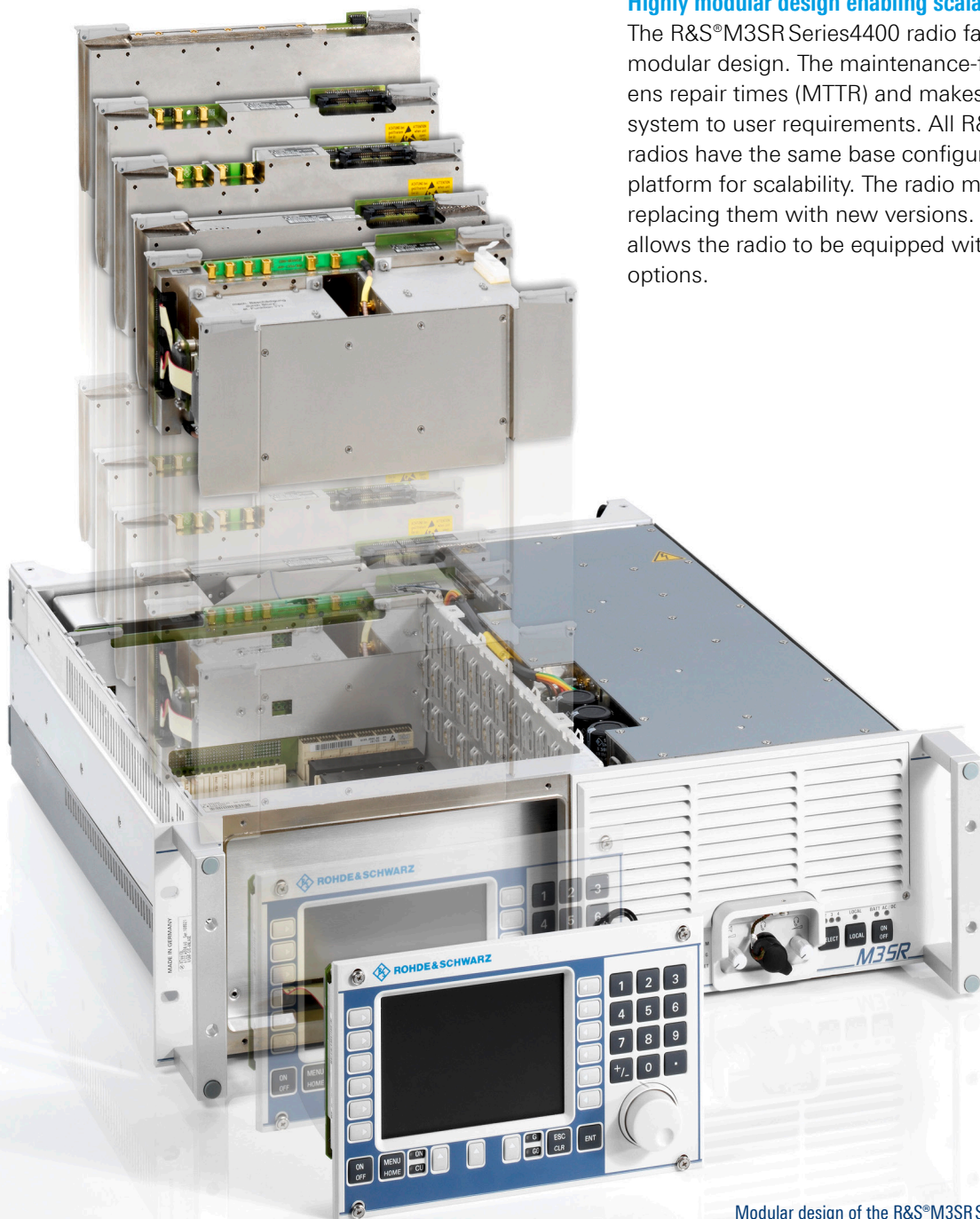

Modular design of the R&S®M3SR Series4400 radio family

### VoIP interface (optional)

The radio provides a VoIP interface in addition to the analog ports. The VoIP interface allows users to establish redundant and IP based communications systems using modern system concepts. The radio provides a state-of-the-art voice communications solution in line with the EUROCAE ED-137 standard to ensure international interoperability.

### Flexibility when selecting the voltage source (multirange AC power supply, direct DC input)

All R&S®M3SR Series4400 radios come with two independent DC inputs. One input is used for the main power supply, and the other for a redundant source. The radio monitors both inputs. An external multirange AC power supply available from Rohde&Schwarz enables operation of the radio with conventional AC power grids.

The power supply is monitored automatically by means of a BIT function in the R&S®M3SR Series4400 radio. The AC power supply complies with current standards and contains active power factor correction. Supply voltage fluctuations are compensated for without affecting radio operation.

R&S®M3SR Series4400 in a mobile ATC tower



R&S®M3SR Series4400 used for civil/military ATC applications



R&S®M3SR Series4400 used on naval platforms



# FLEXIBLE AND SAFE INVESTMENT FOR THE FUTURE

R&S®M3SR Series4400 radios offer a safe investment for the future. The flexible concept is designed for long-term use. The functionality of the system can be expanded via hardware and software to adapt it to new requirements.

## Hardware and software upgrades

The software defined architecture of the R&S®M3SR Series4400 radios makes it possible to procure equipment with the required, up-to-date functionality. Upgrading and reconfiguring at a later point enables the user to adapt the radios to changing requirements and needs. This permits a timely response to new standards and user requirements and is the most cost-effective approach to procuring radio equipment.

## Integrated in the NATO logistics structure

The R&S®M3SR Series4400 radio family is included in the NATO logistics structure. Current R&S®M3SR Series4400 radio models have a NATO stock number (NSN).

The parts and components were selected specifically with reliability and long-term availability in mind to assure their reliable procurement over a long time frame. When selecting parts, Rohde&Schwarz relied on its decades of experience in the production of high-quality electronic equipment.

## Low lifecycle costs

The R&S®M3SR Series4400 radio family features convincingly low lifecycle costs that are achieved through:

- ▶ Minimum training due to the user-friendly GUI concept
- ▶ Fast on-site repairs due to module replacement; very low MTTR (15 min)
- ▶ Integrated, highly-precise, stable clocking source (OCXO)
- ▶ Washable, reusable dust protection
- ▶ Software-regulated cooling fans
- ▶ High MTBF



R&S®M3SR Series4400 radios used in semi-mobile installations

# LOW MAINTENANCE

The R&S®M3SR Series4400 radios were developed with low maintenance in mind. A variety of control and monitoring functions are available that support the user with detailed status information about the radios. Built-in test functions permit service and maintenance tasks to be carried out in a targeted manner. The radios can be remotely analyzed, eliminating the need for on-site service. Resistance to vibrations and a wide operating temperature range allow the radios to be used in diverse applications.

## IP based maintenance tool supporting radio cloning

The IP based R&S®ZS4400 service and maintenance tool is a vital accessory for the R&S®M3SR Series4400 radios. It works in any standard IP network, requires no additional cable and can be used on conventional computers.

A wealth of useful functions not only track the status of the radios in detail, but also transfer configurations from one radio to another (cloning). Cloning permits the fast, time-saving and error-free dissemination of radio-specific settings to the R&S®M3SR Series4400 radios. Cloning makes it easier to replace a radio with another radio of the same type if service and maintenance is required. The R&S®ZS4400 service and maintenance tool is also used to load the radio software.

## Powerful built-in test (BIT)

In addition to the normal power-on BIT (PBIT) and continuous BIT (CBIT), the R&S®M3SR Series4400 also features an initiated BIT (IBIT) for checking the receive and transmit functions of the radio. The transmitter and receiver are tested by means of an internal loopback. The radio analyzes the signal on the receive side and documents any deviations. The R&S®GB4000C remote/local control unit contains an IBIT that can also be used to perform an on-site interactive check of the functions. The IBIT can be carried out after radio upgrade or at regular intervals without external test equipment.

## No tuning of the RF modules required

The R&S®M3SR Series4400 radio modules require no calibration. If a module is replaced or if a radio is extended with additional modules, no manual settings are required on the modules.

A built-in, high-grade oven-controlled crystal oscillator (OCXO) ensures high frequency accuracy.

## High reliability

Rohde & Schwarz boasts decades of experience in the design and production of electronic modules, particularly for RF applications, which ensures that its R&S®M3SR Series4400 radios provide a high level of reliability and functional readiness.

The perfect synergy of mechanical design, temperature monitoring and cooling makes sure that high ambient temperatures, vibrations and humidity do not impact performance or cause damage to the radio. The extremely powerful, software-controlled cooling assures stable continuous operation and long life even in unfavorable ambient conditions such as low air pressure. The MTBF achieved in practice is more than 80 000 operating hours.

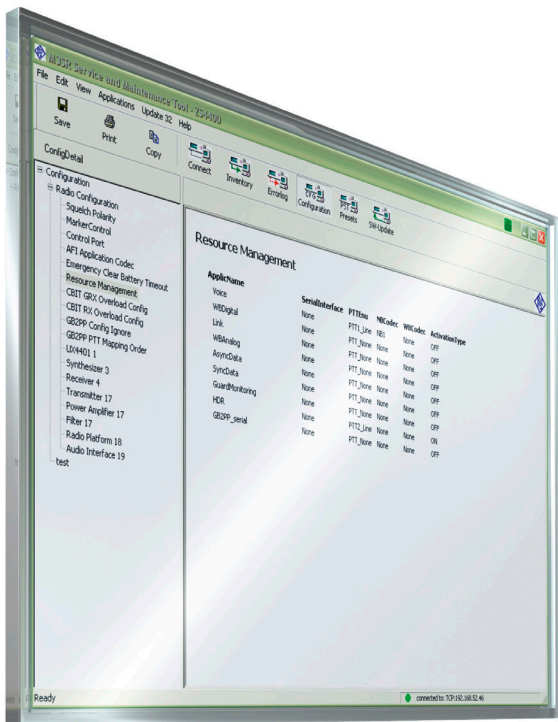

R&S®ZS4400 service and maintenance tool

# RADIOS IN A MOBILE ATC TOWER

The R&S®M3SR Series4400 is designed to be used in mobile military and civil ATC tower solutions. Since multiple radios and their associated antennas must be simultaneously operated in extremely tight quarters, users face a highly demanding RF environment. This can be overcome by deploying integrated R&S®M3SR Series4400 filters and by using external Rohde & Schwarz VHF/UHF filter units.

Such filter concepts are essential, particularly for voice and data applications that use EPM (ECCM) waveforms.

The radios are fully operated via IP with R&S®VCS-4G and R&S®GB4000C remote control units. IP telephones and voice recorders are part of the IP-based system.

## Typical semi-mobile ground/air/ground communications solution

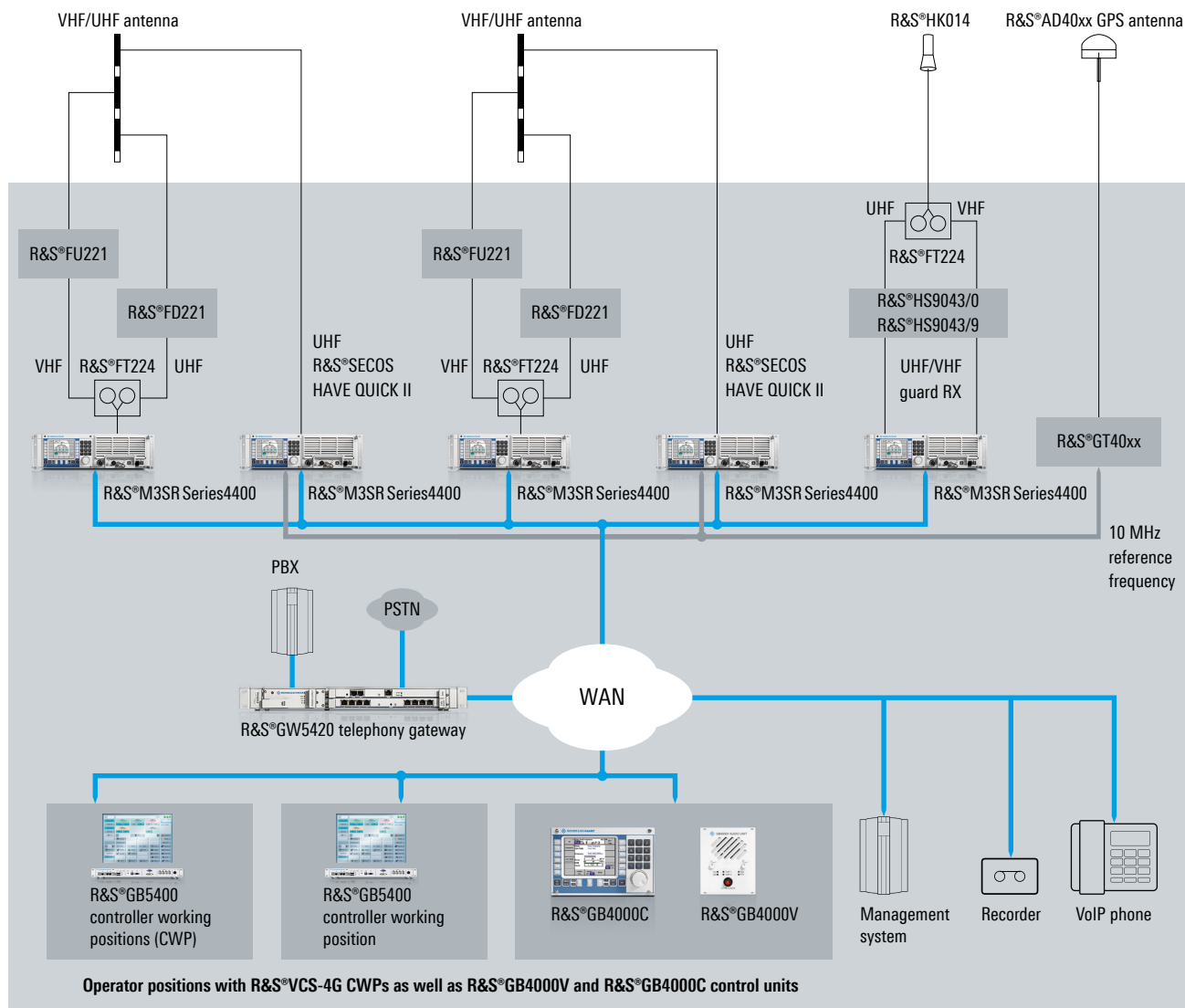

# REMOTE CONTROL AND MONITORING OF RADIOS

A vast majority of the military and civil ATC radios within a country are interlinked via secure networks. These networks enable the monitoring and remote control of nationwide ground/air/ground communications systems. Depending on the requirements, multiple remote control and monitoring stations are deployed.

The R&S®RCMS II system provides centralized and decentralized remote control and monitoring of Rohde&Schwarz radios from one or more sites. Operators can use this software solution to cost-effectively and rapidly respond to error conditions and to configure operational parameters for the respective scenarios.

R&S®RCMS II is designed for monitoring scenarios ranging from individual airports to nationwide systems. The radios are shown in both a tree view and a map view. The map view shows the location and basic configuration of each radio. Individual radios can be quickly selected and managed. For users who wish to perform their own statistical analysis, R&S®RCMS II records the relevant data and makes it available via a data export interface. R&S®RCMS II can be flexibly configured for specific radios. The remote control and monitoring of a nationwide system is carried out from a central station. For maintenance purposes, R&S®RCMS II clients are deployed at the radio sites. Additional Rohde&Schwarz radios can be brought into the R&S®RCMS II system quickly and easily.

## Monitoring and remote control of a nationwide ground/air/ground radio system

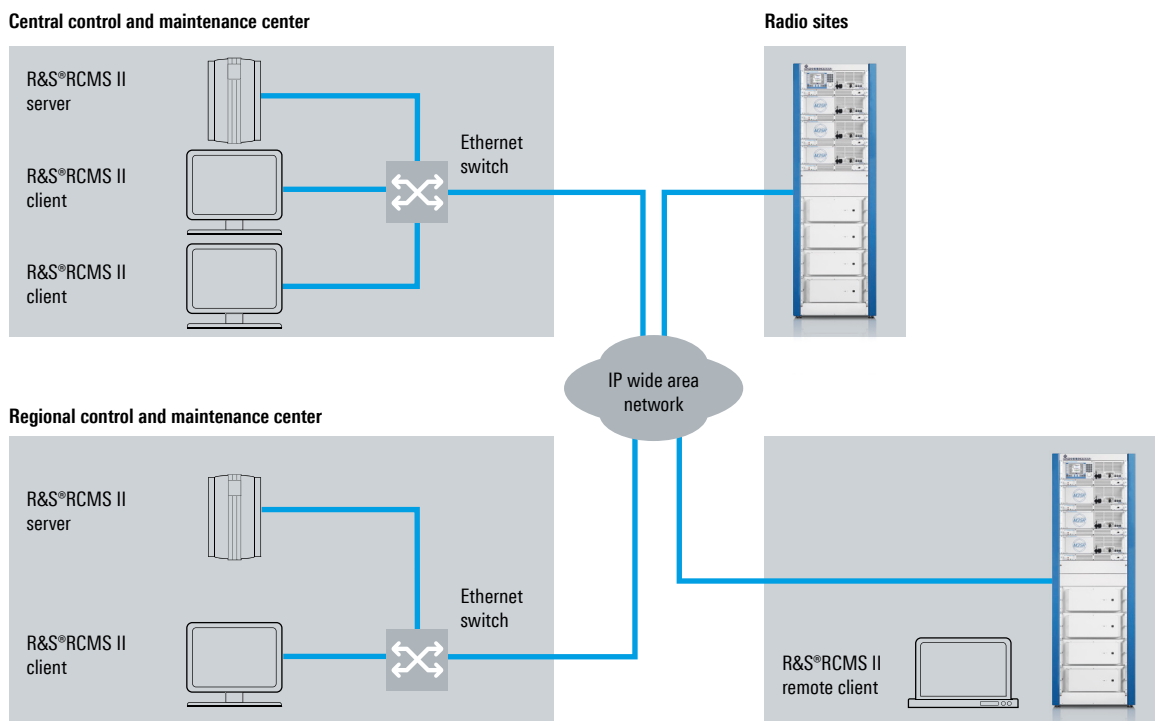

# VOICE OVER INTERNET PROTOCOL (VoIP)

The R&S®M3SR Series4400 radios offer a voice over IP (VoIP) interface in addition to the analog ports. VoIP operates on a standard IP infrastructure and eliminates the need for conventional analog infrastructures.

The R&S®M3SR VoIP solution is based on the EUROCAE ED-137 VoIP standard.

Signals such as PTT and squelch are also transmitted via VoIP, making such systems much easier and less expensive to connect. Redundancy can be economically and effectively built into the infrastructure.

The radio's analog interfaces remain active and can be used as usual.

## IP based VCS

The R&S®M3SR Series4400 radios can be used together with the R&S®VCS-4G voice communications system (VCS), as shown in the figure below. The R&S®VCS-4G takes full advantage of IP technology to provide a scalable, cost-effective solution. It supports VCS services, such as air-to-ground communications, intercom and telephony services. The IP-based distributed architecture provides additional benefits, such as the integration of new services and pay-as-you-grow scalability. The R&S®VCS-4G is compliant with EUROCAE ED-137.

## Application scenarios for Rohde & Schwarz VoIP solutions

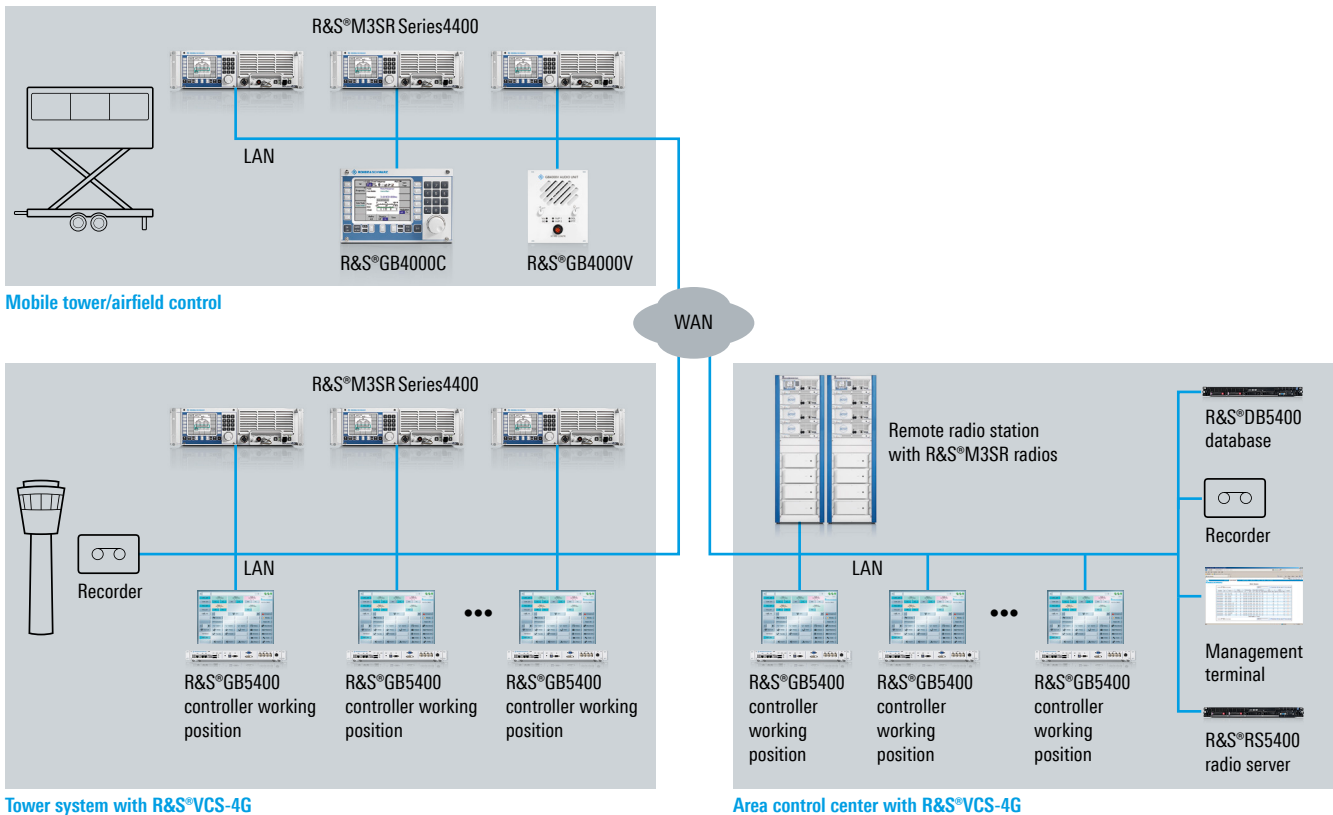



### R&S®GB4000C/R&S®GB4000V pairing for VoIP operation

An R&S®GB4000C remote control unit and an R&S®GB4000V audio unit are configured as a functional pair for VoIP operation. This functionality allows automatic VoIP link establishment between a radio and a remote R&S®GB4000V audio unit. Selecting a radio via the R&S®GB4000C remote control unit automatically forces the R&S®GB4000V audio unit to establish a VoIP session with the selected radio.

The R&S®GB4000C/R&S®GB4000V pairing for VoIP operation is used in mobile tower/airfield control solutions as given in the application scenario.

This functionality is very easy to set up and adjust. It requires extremely little space and is deployed in conventional IP networks. The pairing functionality is ideal for small radiocommunications systems in shelters or on small ships. Since the remote control unit and audio unit are separate, they can be installed at different locations for optimal, flexible use.

### Interoperability

EUROCAE issued the ED-137 standard, which specifies the use of IP for voice communications in ATC environments. This standard was defined jointly by EUROCAE, ATC authorities and ATC equipment manufacturers. Users who select equipment that meets this standard can be assured that the various system components interoperate properly with one another.



R&S®GB4000V audio unit

### R&S®GB4000C/R&S®GB4000V pairing for VoIP operation

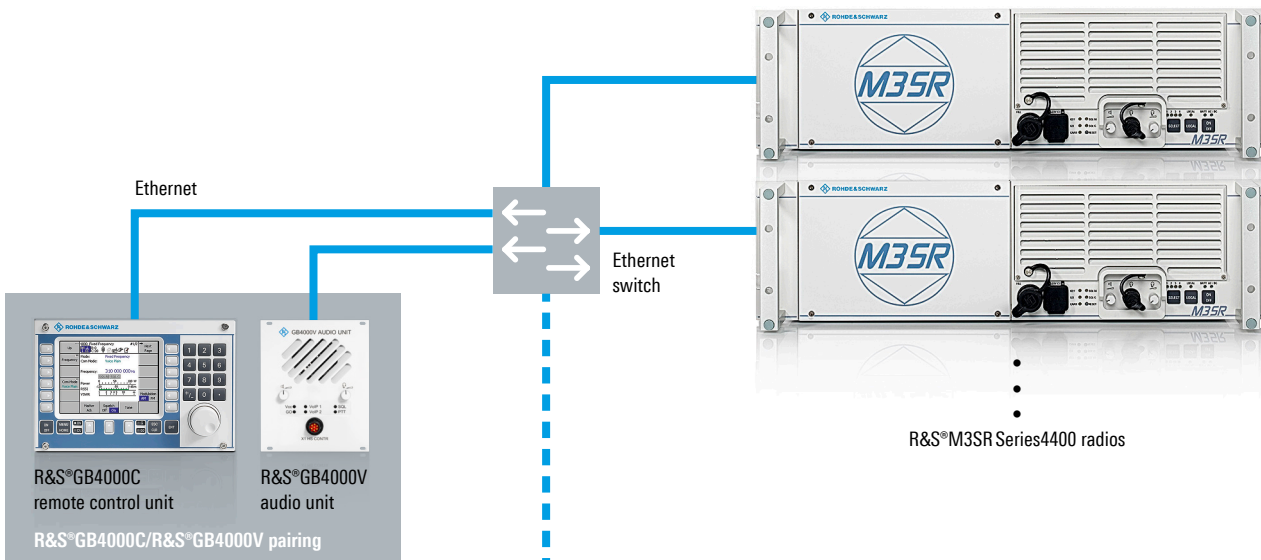

R&S®M3SR Series4400 radios

# HIGH DATA RATE NETWORK SOLUTIONS

The demand for high data rates is constantly growing along with the volume of accumulated data. This calls for transmission methods that provide high data rates at the lowest possible RF bandwidth. The high data rate (HDR) concept of the R&S®M3SR Series4400 radio family meets this need.

The optional R&S®UX4401 70 MHz IF converter interface is used to connect commercially available data modems with IF interfaces to the R&S®M3SR Series4400 radio family. Conversion of the IF signal to the UHF band is

carried out by the R&S®M3SR Series4400 radios. These types of data transmission concepts open up a wide range of different naval and ground based applications. Existing R&S®M3SR Series4400 radios can be extended with an R&S®UX4401 IF converter interface.

The figure below illustrates a typical maritime HDR communications network established with R&S®M3SR Series4400 radios. Such maritime networks provide data communications between multiple nodes.

## Maritime network

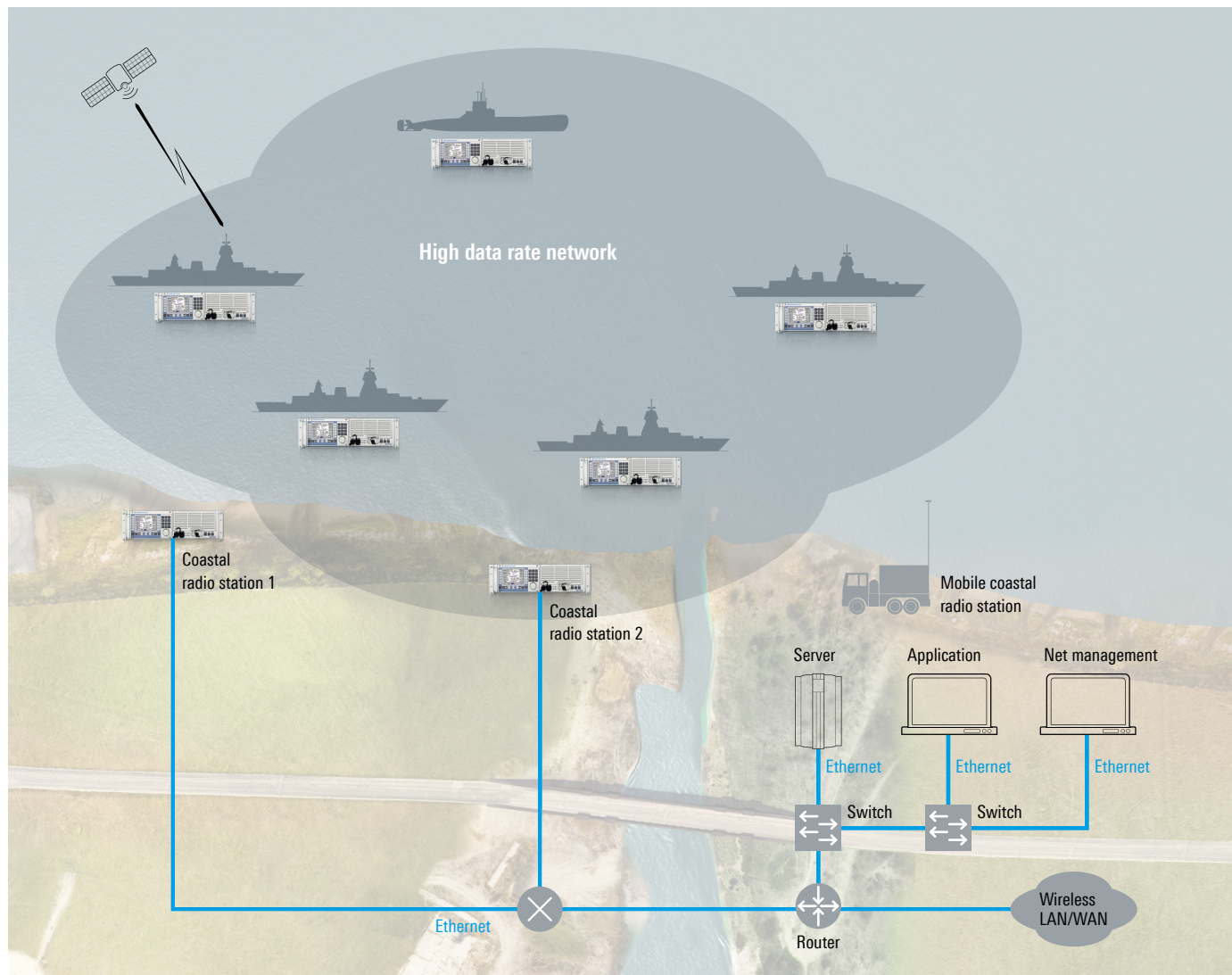

# PRODUCT OVERVIEW

| Designation   | Type         |
|---|--------------|
| <b>Transceiver with fixed frequency functionality</b>   |              |
| VHF/UHF transceiver, with local control unit, OCXO, ruggedized  | R&S°XT4410A  |
| <b>Transceiver with EPM (ECCM) functionalities</b>  |              |
| VHF/UHF transceiver, with HAVE QUICK II and R&S°SECOS 5/16, with local control unit, OCXO, ruggedized                                 | R&S°XT4410E  |
| VHF/UHF transceiver, with R&S°SECOS 2/12, with local control unit, OCXO, ruggedized   | R&S°XT4410K  |
| VHF/UHF transceiver, with R&S°SECOS 5/16, with local control unit, OCXO, ruggedized   | R&S°XT4410L  |
| VHF/UHF transceiver, with HAVE QUICK II, with local control unit, OCXO, ruggedized  | R&S°XT4410J  |
| VHF/UHF transceiver, with SATURN/HAVE QUICK II, with local control unit, OCXO, ruggedized   | R&S°XT4410M  |
| <b>Radio hardware options</b>   |              |
| Mountable control panel   | R&S°GB4000C  |
| VHF/UHF guard receiver  | R&S°ET4400G  |
| UHF EPM filter  | R&S°FD4430   |
| UHF 70 MHz upconverter/downconverter interface  | R&S°UX4401   |
| UHF circulator with VHF bypass  | R&S°GD4400   |
| Various RX antenna interfaces   | R&S°GI4403   |
| <b>Radio software options</b>   |              |
| License for TDMA support  | R&S°GS4400TD |
| License for SPC interface support (for LINK22)  | R&S°GS4400SP |
| License for voice over internet protocol (VoIP) support   | R&S°GS4400VP |
| License for multitone modem support   | R&S°GS4400MT |
| <b>Accessories</b>  |              |
| <b>Mating connector sets, power supplies and remote control unit</b>  |              |
| Mating connector set, suitable for all R&S°M3SR Series4400 radios, with/without circular connector                                    | R&S°ZF4410   |
| Power supply, AC/DC, front panel with dust filter and prepared for IP32, ruggedized, 19", 1 HU  | R&S°IN4000A  |
| Power supply cable, R&S°M3SR Series4400 ↔ R&S°IN4000A, length: 0.5 m/1 m/2.5 m  | R&S°GK4103   |
| Control panel for R&S°M3SR, without audio, with software and LAN, DC, ruggedized  | R&S°GB4000C  |
| Mating connector set for R&S°GB4000C  | R&S°ZF4410   |
| <b>Audio accessories</b>  |              |
| Audio unit for R&S°M3SR Series4400 (analog/VoIP), front panel, ¼ 19"; for one headset (NF-7 connector)                                | R&S°GB4000V  |
| Mating connector set for R&S°GB4000V  | R&S°ZF4000V  |
| Headset, including microphone, ruggedized, with cable and NF-7 connector  | R&S°GA012    |
| Headset, dynamic, with cable and NF-7 connector; with active guard  | R&S°GA015    |
| Headset, dynamic, with cable and NF-7 connector; without active guard   | R&S°GA015A   |
| Microphone, with cable and NF-7 connector, handheld type  | R&S°GA016H1  |
| <b>Service and maintenance tool</b>   |              |
| Service and maintenance tool  | R&S°ZS4400   |
| <b>Radio test equipment</b>   |              |
| Base system, complete set of radio test equipment including system racks and base software suite                                      | R&S°UCS226XB |
| R&S°M3SR Series4400 BASE, system interface base, radio adaptation box and cabling set, including specific radio test software package | R&S°UCS-B10  |
| <b>Timing system</b>  |              |
| SecureSync timing system, Rubidium standard, 3 × 10 MHz, 1 × STANAG/HQ output   | R&S°GT4031   |

Available equipment as listed, other equipment on request.

The radio systems described are hardware- and software-configurable. The system delivered has the configuration as confirmed in the order.

Your local Rohde & Schwarz expert will help you determine the optimum solution for your requirements.

To find your nearest Rohde & Schwarz representative, visit [www.sales.rohde-schwarz.com](http://www.sales.rohde-schwarz.com)

## Service that adds value

- ▶ Worldwide
- ▶ Local and personalized
- ▶ Customized and flexible
- ▶ Uncompromising quality
- ▶ Long-term dependability

## Rohde & Schwarz

The Rohde & Schwarz technology group is among the trailblazers when it comes to paving the way for a safer and connected world with its leading solutions in test and measurement, technology systems, and networks and cybersecurity. Founded more than 85 years ago, the group is a reliable partner for industry and government customers around the globe. The independent company is headquartered in Munich, Germany and has an extensive sales and service network with locations in more than 70 countries.

[www.rohde-schwarz.com](http://www.rohde-schwarz.com)

## Sustainable product design

- ▶ Environmental compatibility and eco-footprint
- ▶ Energy efficiency and low emissions
- ▶ Longevity and optimized total cost of ownership

Certified Quality Management  
**ISO 9001**

Certified Environmental Management  
**ISO 14001**

Certified Quality Management  
**AQAP-2110**

## Rohde & Schwarz training

[www.training.rohde-schwarz.com](http://www.training.rohde-schwarz.com)

## Rohde & Schwarz customer support

[www.rohde-schwarz.com/support](http://www.rohde-schwarz.com/support)

